

# SEAMLESS WELDED FITTINGS

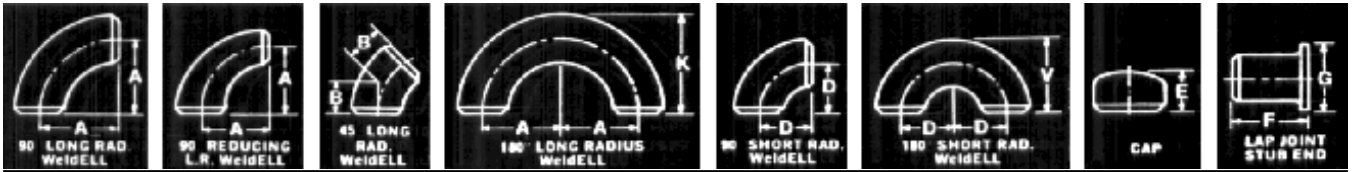

NPS	Pipe O.D.	WALL THICKNESS													A	B	K	D	V	E	F		G	NPS	
		① Light Wall	SCH 20	SCH 30	② STD	SCH 40	SCH 60	③ X-Sig	SCH 80	SCH 100	SCH 120	SCH 140	SCH 160	XX Stg							ASA	MSS			
1/2	.840	.083	---	---	.109	.109	---	.147	.147	---	---	---	.188	.294	1 1/2	5/8	1 1/8	---	---	1	3	2	1 1/8	1/2	
3/4	1.050	.083	---	---	.113	.113	---	.154	.154	---	---	---	.219	.308	1 1/8	7/16	1 1/16	---	---	1 1/2	3	2	1 1/16	3/4	
1	1.315	.109	---	---	.133	.133	---	.179	.179	---	---	---	.250	.358	1 1/2	7/8	2 1/16	1	---	1 1/2	4	2	2	1	
1 1/4	1.660	.109	---	---	.140	.140	---	.191	.191	---	---	---	.250	.382	1 7/8	1	2 1/4	1 1/4	2 1/16	1 1/2	4	2	2 1/2	1 1/4	
1 1/2	1.900	.109	---	---	.145	.145	---	.200	.200	---	---	---	.281	.400	2 1/4	1 1/8	3 1/4	1 1/2	2 1/16	1 1/2	4	2	2 3/8	1 1/2	
2	2.375	.109	---	---	.154	.154	---	.218	.218	---	---	---	.344	.436	3	1 3/8	4 3/16	2	3 1/16	1 1/2	6	2 1/2	3 3/16	2	
2 1/2	2.875	.120	---	---	.203	.203	---	.276	.276	---	---	---	.375	.552	3 3/4	1 3/4	5 1/16	2 1/2	3 15/16	1 1/2	6	2 1/2	4 1/8	2 1/2	
3	3.500	.120	---	---	.216	.216	---	.300	.300	---	---	---	.438	.600	4 1/2	2	6 1/4	3	4 3/4	2	6	2 1/2	5	3	
3 1/2	4.000	.120	---	---	.226	.226	---	.318	.318	---	---	---	.---	.636	5 1/4	2 1/4	7 1/4	1 1/2	5 1/2	2 1/2	6	3	5 1/2	3 1/2	
4	4.500	.120	---	---	.237	.237	---	.337	.337	---	.438	---	.531	.674	6	2 1/2	8 1/4	4	6 1/4	2 1/2	6	3	6 1/16	4	
5	5.563	.134	---	---	.258	.258	---	.375	.375	---	.500	---	.625	.750	7 1/2	3 1/8	10 5/16	5	7 3/4	3	8	3	7 5/16	5	
6	6.625	.134	---	---	.280	.280	---	.432	.432	---	.562	---	.719	.864	9	3 3/4	12 5/16	6	9 5/16	3 1/2	8	3 1/2	8 1/2	6	
8	8.625	.148	.250	.277	.322	.322	.406	.500	.594	.719	.812	.906	.875	12	5	16 5/16	8	12 5/16	4	8	4	10 3/8	8		
10	10.750	.165	.250	.307	.365	.365	.500	.594	.719	.844	1.000	1.125	1.000	15	6 1/4	20 3/8	10	15 5/8	5	10	5	12 1/4	10		
12	12.750	.180	.250	.330	.375	.406	.562	.500	.688	.844	1.000	1.125	1.312	1.000	18	7 1/2	24 3/8	12	18 3/8	6	10	6	15	12	
14	14.000	.250	.312	.375	.375	.438	.594	.500	.750	.938	1.094	1.250	1.406	---	21	8 3/4	28	14	21	6 1/2	12	---	16 1/4	14	
16	16.000	.250	.312	.375	.375	.500	.656	.500	.844	1.031	1.219	1.438	1.594	---	24	10	32	16	24	7	12	---	18 1/2	16	
18	18.000	.250	.312	.438	.375	.562	.750	.500	.938	1.156	1.375	1.562	1.781	---	27	11 1/4	36	18	27	8	12	---	21	18	
20	20.000	.250	.375	.500	.375	.594	.812	.500	1.031	1.281	1.500	1.750	1.969	---	30	12 1/2	40	20	30	9	12	---	23	20	
24	24.000	.250	.375	.562	.375	.688	.969	.500	1.219	1.531	1.812	2.062	2.344	---	36	15	48	24	36	10 1/2	12	---	27 1/4	24	
30	30.000	.312	.500	.625	.375	---	---	.500	---	---	---	---	---	---	45	18 1/2	60	30	45	10 1/2	---	---	---	30	
36	36.000	.312	.500	.625	.375	.750	---	.500	---	---	---	---	---	---	54	22 1/4	---	36	54	10 1/2	---	---	---	36	
42	42.000	---	---	---	.375	---	---	.500	---	---	---	---	---	---	63	26	---	48	---	12	---	---	---	---	42

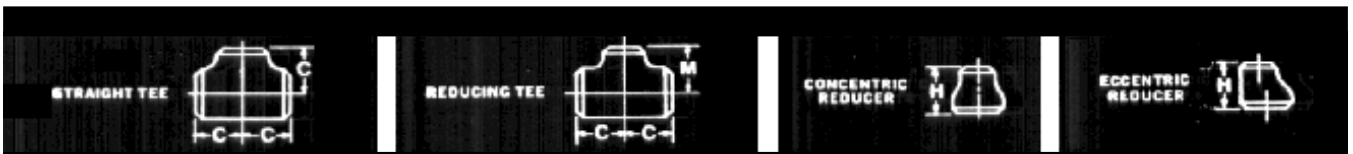

NPS	Outlet	C	M	H	NPS	Outlet	C	M	H	NPS	Outlet	C	M	H	NPS	Outlet	C	M	H		
3/4	3/4	1 1/8	---	---	4	4	4 1/8	---	---	14	14	11	---	---	30	30	22	---	---		
1	1/2	1 1/8	1 1/8	1 1/2		3 1/2	4 1/8	4	4		12	11	10 5/8	13		---	24	24	22	21	24
1	1	1 1/2	---	---		3	4 1/8	3 3/8	4		10	11	10 1/8	13		---	20	22	20	20	24
1 1/4	3/4	1 1/2	1 1/2	2		2 1/2	4 1/8	3 3/4	4		8	11	9 3/4	13		---	18	22	19 1/2	24	24
1 1/4	1/2	1 1/2	1 1/2	2	2	4 1/8	3 1/2	4	6	11	9 3/8	13	---	16	22	19	24	24			
1 1/4	1 1/8	---	---	---	1 1/2	4 1/8	3 3/8	4	14	22	19	24	---	14	22	19	24	24			
1 1/4	1	1 1/8	1 1/8	2	5	5	4 7/8	---	---	16	16	12	---	---	36	36	26 1/2	---	---		
1 1/4	3/4	1 1/8	1 1/8	2		4	4 7/8	4 5/8	5		14	12	12	14		---	30	26 1/2	24	24	24
1 1/4	1/2	1 1/8	1 1/8	2		3 1/2	4 7/8	4 1/2	5		12	12	11 5/8	14		---	24	26 1/2	25	24	24
1 1/2	1 1/2	2 1/4	---	---		3	4 7/8	4 3/8	5		10	12	11 1/8	14		---	20	26 1/2	23	24	24
1 1/2	1 1/4	2 1/4	2 1/4	2 1/2	2 1/2	4 7/8	4 1/4	5	8	12	10 3/4	14	---	18	26 1/2	22 1/2	24	24			
1 1/2	1	2 1/4	2 1/4	2 1/2	2	4 7/8	4 1/8	5	6	12	10 3/8	14	---	16	26 1/2	22	24	24			
2	2	2 1/2	---	---	6	6	5 5/8	---	---	18	18	13 1/2	---	---	42	42	30	---	---		
2	1 1/2	2 1/2	2 3/8	3		5	5 5/8	5 3/8	5 1/2		16	13 1/2	13	15		---	36	30	28	24	24
2	1 1/4	2 1/2	2 1/4	3		4	5 5/8	5 1/8	5 1/2		14	13 1/2	13	15		---	30	30	28	24	24
2	1	2 1/2	2	3		3 1/2	5 5/8	4 7/8	5 1/2		12	13 1/2	12 5/8	15		---	24	30	26	24	24
2	3/4	2 1/2	1 3/4	3	2 1/2	5 5/8	4 3/4	5 1/2	10	13 1/2	12 1/8	15	---	20	30	26	24	24			
2 1/2	2 1/2	3	---	---	8	8	7	---	---	20	20	15	---	---	-	---	---	---	---		
2 1/2	2	3	2 3/4	3 1/2		6	7	6 5/8	6		18	15	14 1/2	20		---	---	---	---	---	
2 1/2	1 1/2	3	2 5/8	3 1/2		5	7	6 3/8	6		16	15	14	20		---	---	---	---	---	
2 1/2	1 1/4	3	2 1/2	3 1/2		4	7	6 1/8	6		14	15	14	20		---	---	---	---	---	
2 1/2	1	3	2 1/4	3 1/2	3 1/2	7	6	6	12	15	13 1/8	20	---	---	---	---	---	---			
3	3	3 3/8	---	---	10	10	8 1/2	---	---	24	24	17	---	---	-	---	---	---	---		
3	2 1/2	3 3/8	3 1/4	3 1/2		8	8 1/2	8	7		20	17	17	20		---	---	---	---	---	
3	2	3 3/8	3	3 1/2		6	8 1/2	7 5/8	7		18	17	16 1/2	20		---	---	---	---	---	
3	1 1/2	3 3/8	2 7/8	3 1/2		5	8 1/2	7 1/2	7		16	17	16	20		---	---	---	---	---	
3 1/2	1 1/4	3 3/8	2 3/4	3 1/2	4	8 1/2	7 1/4	7	14	17	16	20	---	---	---	---	---	---			
3 1/2	3 1/2	3 3/4	---	---	12	12	10	---	---	-	---	---	---	---	-	---	---	---	---		
3 1/2	3	3 3/4	3 5/8	4		10	10	9 1/2	8		20	17	16 1/2	20		---	---	---	---	---	
3 1/2	2 1/2	3 3/4	3 1/2	4		8	10	9	8		14	17	16	20		---	---	---	---	---	
3 1/2	2	3 3/4	3 1/4	4		6	10	8 5/8	8		12	17	15 5/8	20		---	---	---	---	---	
3 1/2	1 1/2	3 3/4	3 1/8	4	5	10	8 1/2	8	10	17	15 1/8	20	---	---	---	---	---	---			

- NOTES:**
- Light Wall thicknesses are identical to stainless steel Schedule 10S in Sizes thru 12" and to Schedule 10 in sizes thru 14" and larger.
  - Standard Wall thicknesses are identical to stainless steel Schedule 40S in sizes thru 12".
  - Extra Strong Wall thicknesses are identical to stainless steel Schedule 80S in sizes thru 12".
  - May be of welded pipe, x-rayed and stress-relieved.
  - Other types, sizes and thicknesses of fittings on application.
  - Stocked in carbon steel and a variety of other metals and alloys.

# FORGED STEEL FLANGES



150 LB. FLANGES								300 LB. FLANGES							400 LB. FLANGES									
NPS	O	C <sup>Ⓢ</sup>	Weld Neck	Y <sup>Ⓢ</sup> Slip On Thrd.	Lap Joint	Bolt Circle	No. and Size of Holes	O	C <sup>Ⓢ</sup>	Weld Neck	Y <sup>Ⓢ</sup> Slip On Thrd.	Lap Joint	Bolt Circle	No. and Size of Holes	O	C <sup>Ⓢ</sup>	Weld Neck	Slip On Thrd.	Y <sup>Ⓢ</sup> Lap Joint	Bolt Circle	No. and Size of Holes	Nom. Pipe Size		
1/2	3/2	7/16	17/8	5/8	5/8	2 3/8	4 - 5/8	3 3/4	9/16	2 1/16	7/8	1	1	2 5/8	4 - 5/8	3 3/4	9/16	2 1/16	7/8	1	1	2 5/8	4 - 5/8	1/2
3/4	3 3/8	1 1/2	2 1/16	5/8	5/8	2 3/4	4 - 3/4	4 5/8	5/8	2 1/4	1	1	3 1/4	4 - 3/4	4 7/8	5/8	2 1/4	1	1	3 1/4	4 - 3/4	3/4	3/4	
1	4 1/4	9/16	2 3/16	1 1/16	1 1/16	3 1/8	4 - 5/8	4 7/8	1 1/16	2 7/16	1 1/16	1 1/16	3 1/2	4 - 3/4	5 1/4	1 1/16	2 3/16	1 1/16	1 1/16	3 1/2	4 - 3/4	1	1	
1 1/4	4 5/8	5/8	2 1/4	1 3/16	1 3/16	3 1/2	4 - 5/8	5 1/4	3/4	2 9/16	1 1/16	1 1/16	3 3/8	4 - 3/4	6 1/8	1 3/16	2 5/8	1 1/16	1 1/16	3 3/8	4 - 3/4	1 1/4	1 1/4	
1 1/2	5	1 1/16	2 1/16	7/8	7/8	3 3/8	4 - 5/8	6 1/8	1 3/16	2 1 1/16	1 3/16	1 3/16	4 1/2	4 - 7/8	6 3/8	7/8	2 3/4	1 1/4	1 1/4	4 1/2	4 - 7/8	1 1/2	1 1/2	
2	6	3/4	2 1/2	1	1	4 1/4	4 - 3/4	6 1/2	7/8	2 3/4	1 5/16	1 5/16	5	8 - 3/4	7 1/2	1	3	1 1/2	1 1/2	5 5/8	8 - 3/4	2	2	
2 1/2	7	7/8	2 3/4	1 1/8	1 1/8	5 1/2	4 - 3/4	7 1/2	1	3	1 1/2	1 1/2	5 5/8	8 - 7/8	8 1/4	1 1/8	3 3/8	1 1/8	1 1/8	5 5/8	8 - 7/8	2 1/2	2 1/2	
3	7 1/2	1 5/16	2 3/4	1 3/16	1 3/16	6	4 - 3/4	8 1/2	1 1/8	3 1/8	1 1 1/16	1 1 1/16	6 5/8	8 - 7/8	8 1/4	1 1/4	3 3/4	1 1 1/16	1 1 1/16	6 5/8	8 - 7/8	3	3	
3 1/2	8 1/2	1 5/16	2 3/4	1 3/16	1 3/16	7	8 - 3/4	9	1 1/8	3 1/8	1 1 1/16	1 1 1/16	7 1/4	8 - 7/8	9	1 1/8	3 3/4	1 1 1/16	1 1 1/16	7 1/4	8 - 7/8	3 1/2	3 1/2	
4	9	1 5/16	3	1 5/16	1 5/16	7 1/2	8 - 3/4	10	1 1/4	3 3/8	1 1 1/8	1 1 1/8	7 3/8	8 - 7/8	10	1 3/8	3 1/2	2	2	7 3/8	8 - 1	4	4	
5	10	1 5/16	3 1/2	1 7/16	1 7/16	8 1/2	8 - 7/8	11	1 3/8	3 3/8	2	2	9 1/4	8 - 7/8	11	1 1/2	4	2 1/8	2 1/8	9 1/4	8 - 1	5	5	
6	11	1 7/8	3 1/2	1 7/16	1 7/16	9 1/2	8 - 7/8	12 1/2	1 7/16	3 3/8	2 1/16	2 1/16	10 5/8	12 - 1/8	12 1/2	1 5/8	4 1/16	2 1/8	2 1/8	10 5/8	12 - 1	6	6	
8	13 1/2	1 7/8	4	1 7/8	1 7/8	11 3/4	8 - 7/8	15	1 7/8	4 1/8	2 3/16	2 3/16	13	12 - 1	15	1 7/8	4 5/8	2 1 1/16	2 1 1/16	13	12 - 1 1/8	8	8	
10	16	1 7/8	4	1 7/8	1 7/8	14 1/4	12 - 1	17 1/2	1 7/8	4 5/8	2 3/8	2 3/8	15 1/4	16 - 1 1/8	17 1/2	2 1/8	4 7/8	2 1 1/16	2 1 1/16	4	15 1/4	12 - 1 1/8	10	10
12	19	1 7/8	4 1/2	2 3/16	2 3/16	17	12 - 1	20 1/2	2	5 1/8	2 3/8	2 3/8	17 3/4	16 - 1 1/4	20 1/2	2 1/4	5 3/8	3 3/8	4 1/4	17 3/4	16 - 1 3/8	12	12	
14	21	1 7/8	5	2 1/4	2 1/4	18 3/4	12 - 1 1/8	23	2 1/8	5 5/8	3	3	4 3/8	20 - 1 1/4	23	2 3/8	5 7/8	3 3/16	4 5/8	20 1/4	20 - 1 3/8	14	14	
16	23 1/2	1 7/8	5	2 1/4	2 1/4	21 1/4	16 - 1 1/8	25 1/2	2 1/4	5 5/8	3 1/4	3 1/4	22 1/2	20 - 1 3/8	25 1/2	2 3/8	6	3 1 1/16	5 7/8	20 1/4	20 - 1 1/2	16	16	
18	25	1 7/8	5 1/2	2 1 1/16	2 1 1/16	22 3/4	16 - 1 1/4	28	2 3/8	6 1/4	3 1/2	3 1/2	24 1/4	24 - 1 3/8	28	2 5/8	6 1/2	3 1/8	5 5/8	24 3/4	24 - 1 1/2	18	18	
20	27 1/2	1 7/8	5 1/2	2 1 1/16	2 1 1/16	25	20 - 1 1/4	30 1/2	2 3/8	6 1/4	3 3/4	3 3/4	27	24 - 1 3/8	30 1/2	2 5/8	6 3/8	4	5 5/8	27	24 - 1 5/8	20	20	
24	32	1 7/8	6	3 1/4	3 1/4	29 1/2	20 - 1 3/8	36	2 3/4	6 5/8	4 3/16	4 3/16	32	24 - 1 5/8	36	3	6 7/8	4 1/2	6 1/4	32	24 - 1 7/8	24	24	
30	38 3/4	2 1/8	5 5/8	3 3/4	3 3/4	36	28 - 1 3/8	43	3 3/8	8 1/4	5 1/4	5 1/4	39 1/4	28 - 1 7/8	43	4	8 3/8	5 1/2	6 1/4	39 1/4	28 - 2 1/8	30	30	
36	46	2 3/8	5 5/8	3 3/4	3 3/4	42 3/4	32 - 1 5/8	50	4 1/8	9 1/2	6 1/4	6 1/4	46	32 - 2 1/2	50	4 1/2	9 7/8	6 1/2	6 1/4	46	32 - 2 1/8	36	36	

600 LB. FLANGES								900 LB. FLANGES							1500 LB. FLANGES									
1/2	3 3/4	9/16	2 1/16	7/8	7/8	2 5/8	4 - 5/8	4 3/4	7/8	2 3/8	1 1/4	1 1/4	3 1/4	4 - 7/8	4 3/4	7/8	2 3/8	1 1/4	1 1/4	3 1/4	4 - 7/8	1/2	1/2	
3/4	4 5/8	5/8	2 1/4	1	1	3 1/4	4 - 3/4	5 1/8	1	2 3/4	1 3/8	1 3/8	3 1/2	4 - 3/4	5 1/8	1 1/8	2 3/8	1 3/8	1 3/8	3 1/2	4 - 7/8	3/4	3/4	
1	4 7/8	1 1/16	2 1/16	1 1/16	1 1/16	3 1/2	4 - 3/4	6 1/8	1 1/8	2 1/8	1 5/8	1 5/8	4	4 - 1	6 1/4	1 1/8	2 1/8	1 5/8	1 5/8	4	4 - 1	1	1	
1 1/4	5 1/4	1 3/8	2 5/8	1 1/8	1 1/8	3 7/8	4 - 3/4	7 1/8	1 1/4	2 1/4	1 3/4	1 3/4	4 1/8	4 - 1	8 1/2	1 1/4	2 1/8	1 5/8	1 5/8	4 3/8	4 - 1	1 1/4	1 1/4	
1 1/2	6 1/8	7/8	2 3/4	1 1/4	1 1/4	4 1/2	4 - 7/8	8 1/2	1 1/2	4	2 1/4	2 1/4	6 1/2	4 - 1	9 1/2	1 1/2	4	2 1/8	2 1/8	4 7/8	4 - 1 1/8	1 1/2	1 1/2	
2	6 1/2	1	2 1/2	1 1/16	1 1/16	5	8 - 3/4	9 5/8	1 5/8	4 1/8	2 1/2	2 1/2	7 1/2	8 - 1 1/8	10 1/2	1 5/8	4 3/8	2 1/2	2 1/2	7 1/2	8 - 1 1/8	2 1/2	2 1/2	
2 1/2	7 1/2	1 1/8	3 1/4	1 1 1/16	1 1 1/16	6 1/8	8 - 7/8	9 1/2	1 1/2	4	2 1/8	1 1/8	7 1/2	8 - 1	10 1/2	1 7/8	4 5/8	2 1/8	2 1/8	8	8 - 1 1/4	3	3	
3	8 1/4	1 1/4	3 1/4	1 1 1/16	1 1 1/16	6 3/8	8 - 7/8	11 1/2	1 1/2	4 1/2	2 3/4	2 3/4	9 1/4	8 - 1 1/4	12 1/4	2 1/8	4 7/8	3 3/16	3 3/16	9 1/2	8 - 1 3/8	4	4	
3 1/2	9	1 3/8	3 3/8	1 1 1/16	1 1 1/16	7 1/4	8 - 1	13 1/4	1 3/4	4 3/4	3 1/8	3 1/8	11	8 - 1 3/8	14 1/4	2 3/8	5 1/8	4 1/16	4 1/16	11 1/2	8 - 1 3/8	5	5	
4	10 3/4	1 1/2	4	2 1/8	2 1/8	8 1/2	8 - 1 1/8	15	2 1/8	5 1/2	3 3/8	3 3/8	12 1/2	12 - 1 1/4	15 1/2	3 3/4	6 3/4	4 1 1/16	4 1 1/16	12 1/2	12 - 1 1/4	6	6	
5	13 1/4	1 3/4	4 1/2	2 3/8	2 3/8	10 1/2	12 - 1 1/8	18 1/2	2 1/2	6 1/2	4	4 1/2	15 1/2	12 - 1 1/2	19	3 3/8	8 3/8	5 5/8	5 5/8	15 1/2	12 - 1 3/4	8	8	
6	14	1 7/8	4 5/8	2 3/8	2 3/8	11 1/2	12 - 1 1/4	21 1/2	2 3/4	7 1/4	4 1/4	5	18 1/2	16 - 1 1/2	23	4 1/4	10	6 1/4	7	19	12 - 2	10	10	
8	16 1/2	2 1/8	5 1/4	3	3	13 3/4	12 - 1 1/4	24	3 1/8	7 7/8	4 3/4	5 3/8	21	20 - 1 1/2	26 1/2	4 3/4	11 3/8	7 1/8	8 5/8	22 1/2	16 - 2 1/8	12	12	
10	20	2 3/8	6	3 3/8	3 3/8	17	1 - 1 3/8	25 1/4	3 3/8	8 1/8	5 1/8	6 1/8	22	20 - 1 5/8	29 1/2	5 1/4	11 3/4	---	9 1/2	25	16 - 2 3/8	14	14	
12	22	2 5/8	6 1/8	3 3/8	3 3/8	19 1/4	20 - 1 1/2	27 3/4	3 3/8	8 1/2	5 1/4	6 1/2	24 1/4	20 - 1 3/4	32 1/2	5 3/4	12 1/4	---	10 1/4	27 3/4	16 - 2 5/8	16	16	
14	23 3/4	2 3/4	6 1/2	3 1 1/16	3 1 1/16	4 5/8	20 - 1 1/2	31	4	9	6	7 1/2	27	20 - 2	36	6 3/8	12 7/8	---	10 7/8	30 1/2	16 - 2 7/8	18	18	
16	27	3	7	4 3/16	4 3/16	6	20 - 1 3/4	33 3/4	4 1/4	9 3/4	6 1/4	8 1/4	29 1/2	20 - 2 1/8	38 3/4	7	14	---	11 1/2	32 1/4	16 - 3 1/8	20	20	
18	29 1/4	3 1/4	7 1/2	4 5/8	4 5/8	6	25 3/4	41	5 1/2	11 1/2	8	10 1/2	35 1/2	20 - 2 5/8	46	8	16	---	13	39	16 - 3 3/4	24	24	
20	32	3 1/2	7 1/2	5	5	6 1/2	28 1/2	48 1/2	5 5/8	12 1/4	12 1/4	---	42 3/4	20 - 3 1/8	---	---	---	---	---	---	---	---	30	30
24	37	4	8	5 1/2	5 1/2	7 1/4	33	57 1/2	6 3/4	14 1/4	14 1/4	---	50 3/4	20 - 3 5/8	---	---	---	---	---	---	---	---	36	36

2500 LB. FLANGES							
1/2	5 1/4	1 3/16	2 7/8	1 9/16	1 9/16	3 1/2	4 - 7/8
3/4	5 1/2	1 1/4	3 1/8	1 1 1/16	1 1 1/16	3 3/4	4 - 7/8
1	6 1/4	1 3/8	3 1/2	1 7/8	1 7/8	4 1/4	4 - 1
1 1/4	7 1/4	1 1/2	3 3/4	2 1/16	2 1/16	5 1/8	4 - 1 3/8
1 1/2	8	1 3/4	4 3/8	2 3/8	2 3/8	5 3/4	4 - 1 1/4
2	9 1/4	2	5	2 3/4	2 3/4	6 3/4	8 - 1 1/8
2 1/2	10 1/2	2 1/4	5 5/8	3 1/8	3 1/8	7 3/4	8 - 1 1/4
3	12	2 3/8	6 5/8	3 3/8	3 3/8	9	8 - 1 3/8
4	14	3	7 1/2	4 1/4	4 1/4	10 3/4	8 - 1 5/8
5	16 1/2	3 3/8	9	5 1/8	5 1/8	12 3/4	8 - 1 7/8
6	19	4 1/4	10 3/4	6	6	14 1/2	8 - 2 1/8
8	21 3/4	5	12 1/2	7	7	17 1/4	12 - 2 1/8
10	26 1/2	6 1/2	16 1/2	9	9	21 1/4	12 - 2 5/8
12	30	7 1/4	18 3/4	10	10	24 3/8	12 - 2 7/8

WELDING NECK FLANGE BORES <sup>Ⓢ</sup> <sub>Ⓢ</sub>														
NPS	Outside Diam.	Light Wall	Sched. 20	Sched. 30	Double Std. Wall	Sched. 40	Sched. 60	Extra Strong	Sched. 80	Sched. 100	Sched. 120	Sched. 140	Sched. 160	Extra Strong
1/2	0.840	674	---	---	0.622	0.622	---	0.564	0.546	---	---	---	0.464	0.252
3/4	1.050	884	---	---	0.824	1.049	---	0.742	0.742	---	---	---	0.612	0.434
1	1.315	1.097	---	---	1.049	1.049	---	0.957	0.957	---	---	---	0.815	0.599
1 1/4	1.660	1.442	---	---	1.380	1.380	---							

# FITTINGS

The purpose of a fitting is to change the direction or volume of the flow in piping.

## WELDING FITTINGS

These fittings are made from wrought materials and manufactured in both Seamless and Welded Construction.

### SEAMLESS CONSTRUCTION

The tubing or pipe is heated to a temperature at which the metal is workable and is forced over a mandrel into its final shape. The rough fitting is cooled and machined to apply bevels, then cleaned and marked.

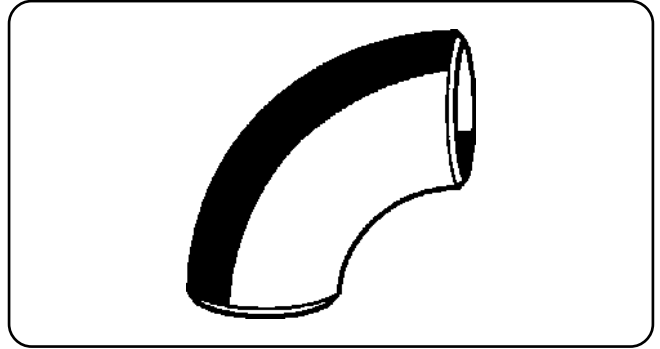

### WELDED CONSTRUCTION

A plate is cut to size and formed in dies. The two sides are welded together. X-Rayed on the weld and then beveled. Fittings can also be manufactured from welded pipe in the same manner as seamless.

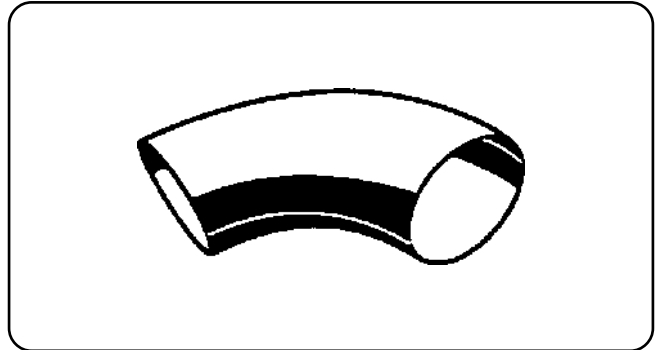

### WELDED FITTING STANDARDS

- |                 |         |  |
|-----------------|---------|--|
| ANSI            | B 16.9  | Dimensional tolerance through NPS 24   |
|                 | B 16.25 | Butt-welding ends  |
|                 | B 16.28 | Wrought Steel butt weld; short radius elbows and return                                    |
| MSS-SP-4S       |         | Dimensional tolerances NPS 26 through NPS 48   |
| Wall thickness: |         | The wall thickness of butt-welding fittings corresponds to the wall thickness of the pipe. |

### SPECIAL ORDER

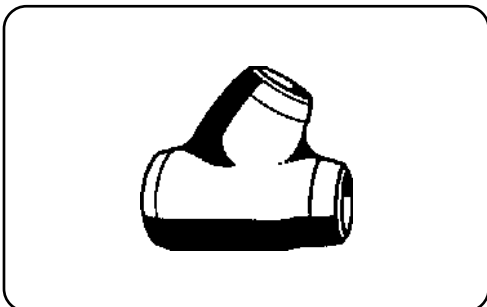

### HEAVY WALL/SPECIAL END FITTINGS

This fitting is for main steam nuclear power.

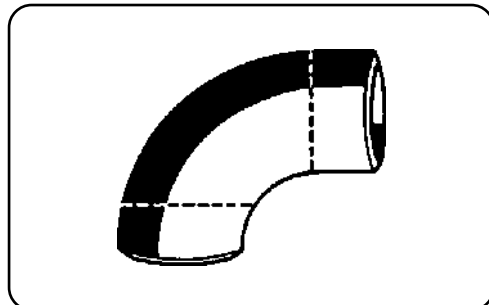

### LONG TANGENT

Square cut ends with ends extended beyond normal center to face dimensions.

# STANDARD FITTING TYPES

## STANDARD BUTT WELD FITTING TYPES

(These fittings are manufactured in both seamless and welded construction)

A long radius ELL has a center to face dimension that is 1.5 times the NPS size of the fitting.

A short radius ELL is 1.0 times the NPS size! Example: a NPS 6 fitting LR=8", SR =6"

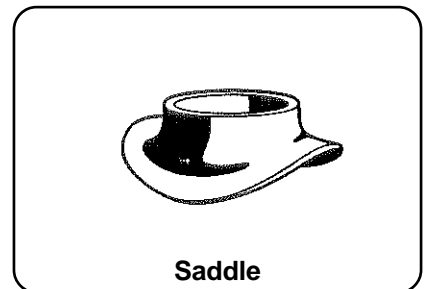
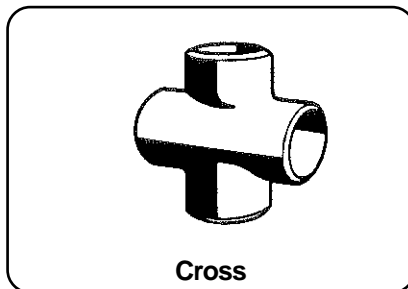
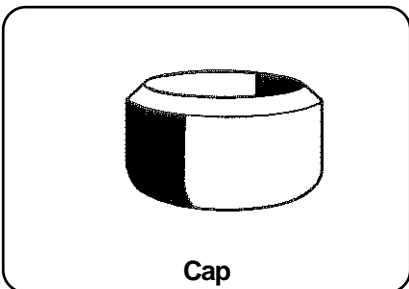
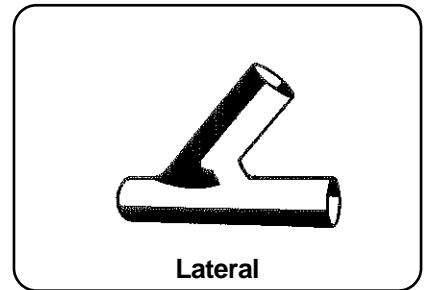
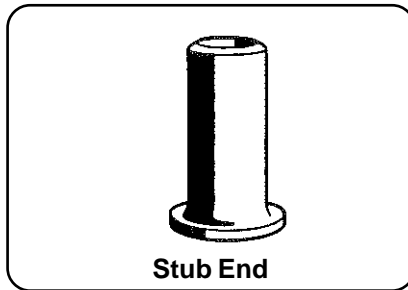
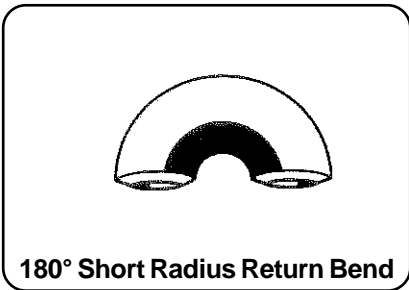
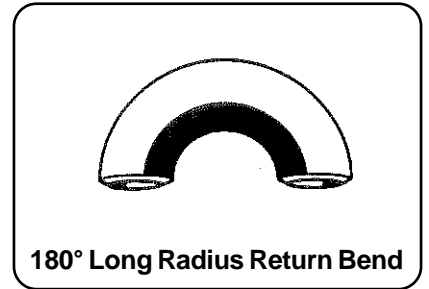
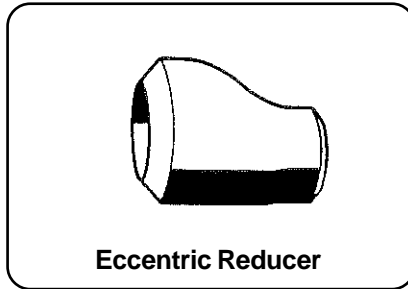
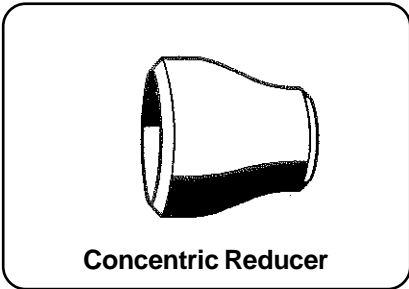
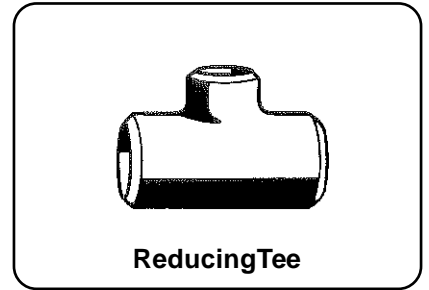
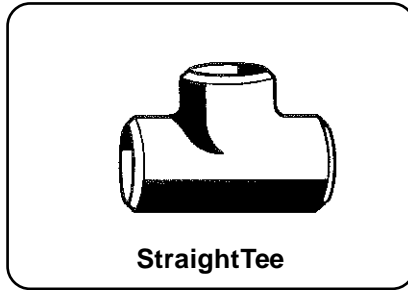
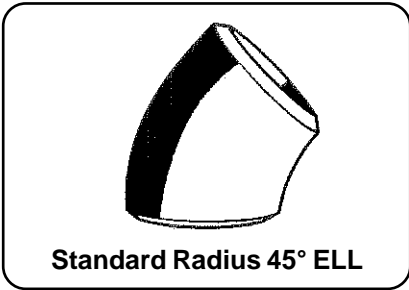
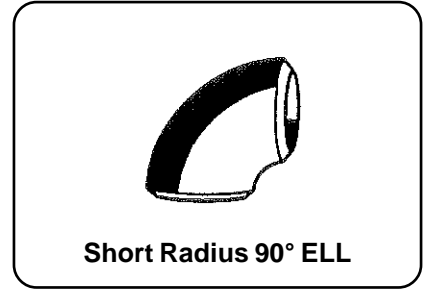
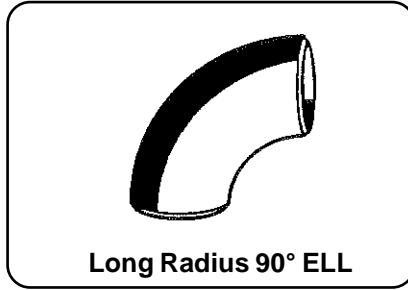

# FITTINGS

## SCREWED FITTINGS

These fittings are made in sizes 1/8" through 4" and in pressure ratings of 150 lb. (1000 lbs. WOG). 2000, 3000 and 6000 lbs. The 150 lb. fitting is made in both cast and forged material. The others are of forged material.

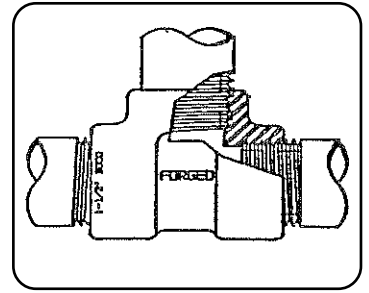

### Screwed Fittings Available:

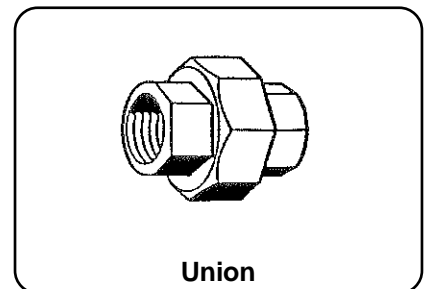
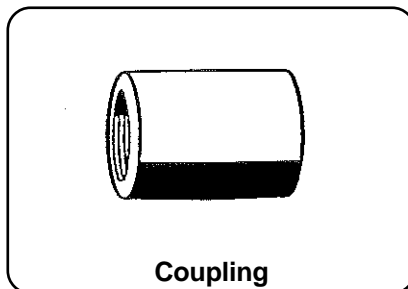
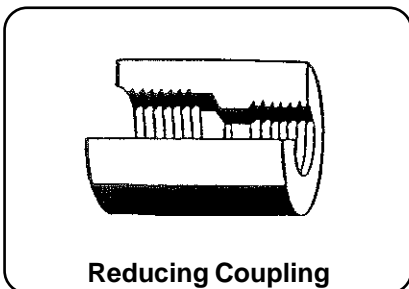
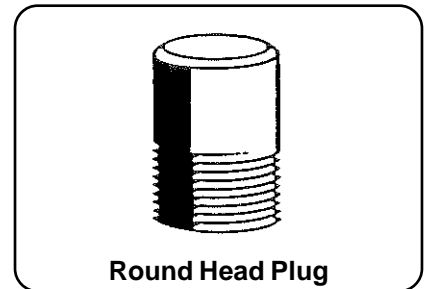
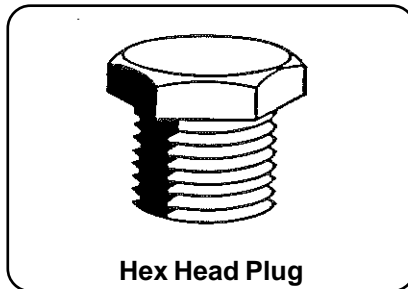
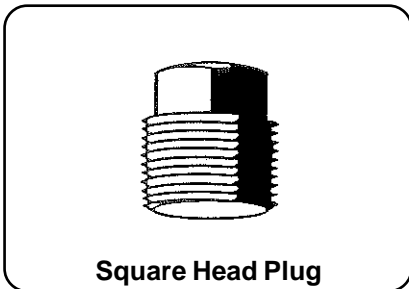
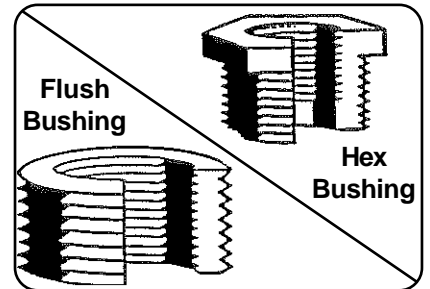
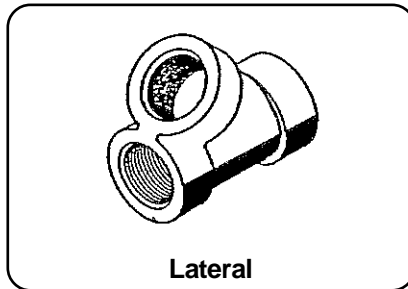
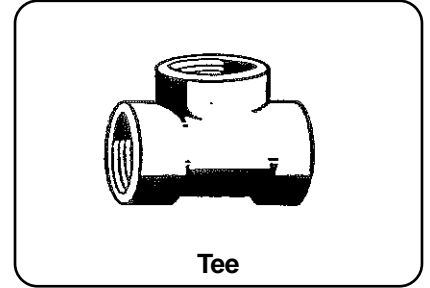
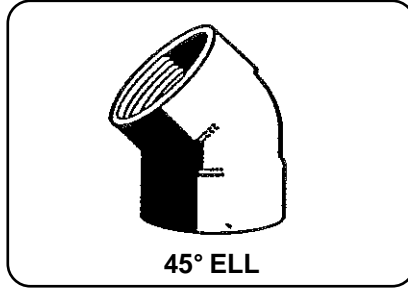
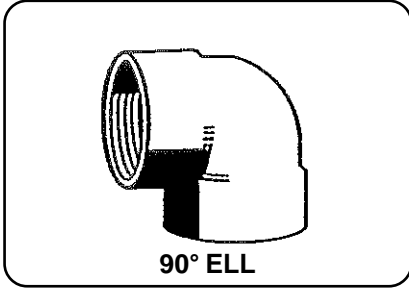

# FITTINGS

## SOCKET WELD FITTINGS

This fitting design has a socket or recess for the pipe to slip into. A back weld is applied to hold the pipe in the fitting. Socket Weld fittings are formed by either the drop forge or upset forging method. They are forged solid and require complete machining.

These fittings can be made of carbon, alloy or stainless steel and in nickel alloys in 150, 3000, 6000 and 9000 lb. ratings. The bore or waterway is machined to conform with Schedule 40, 160 and DXH pipe. They are available in the same shapes and sizes as Screwed Fittings including reducing insert bushings. Special bores may be purchased by agreement.

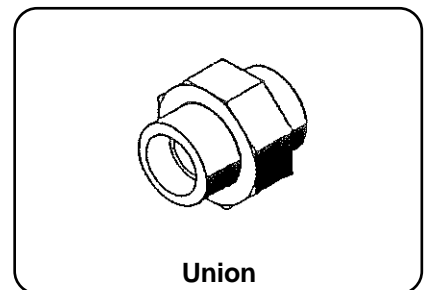
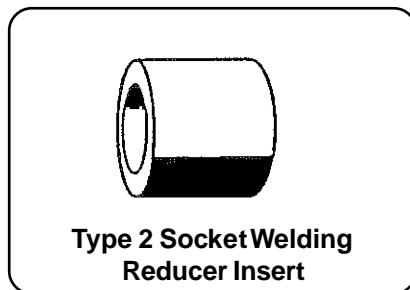
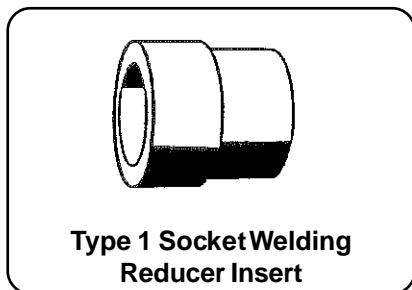
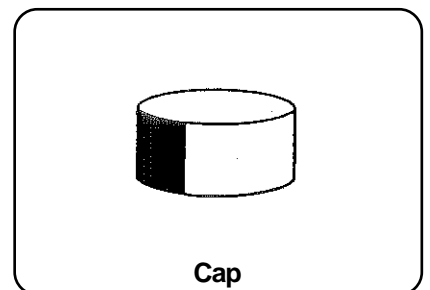
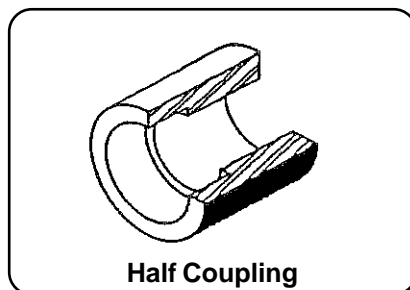
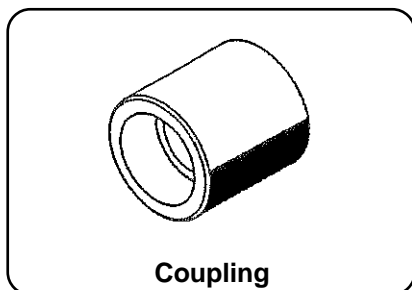
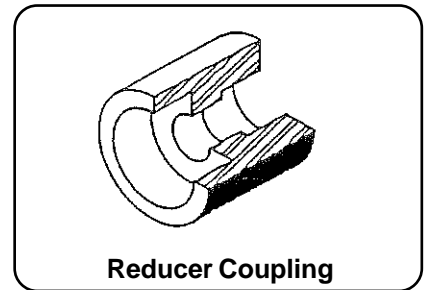
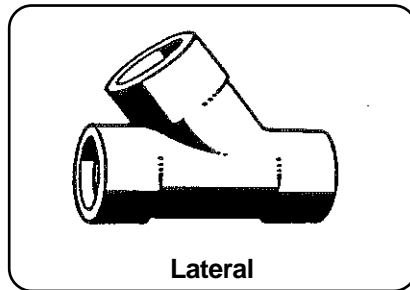
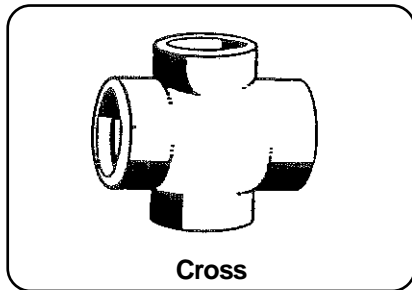
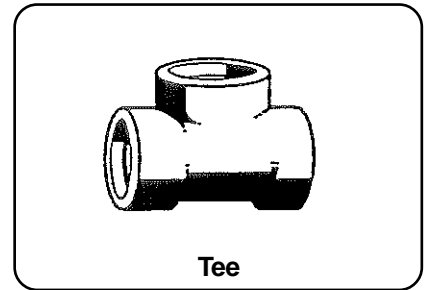
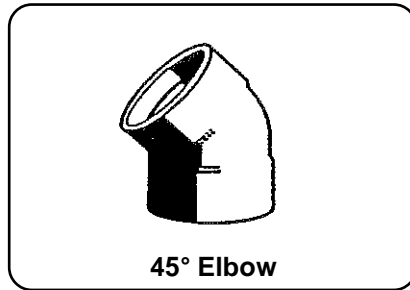
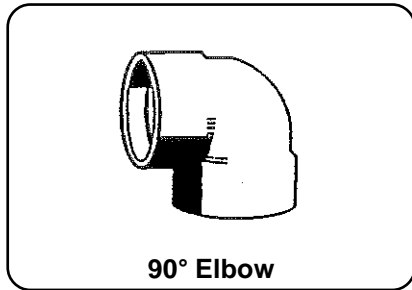
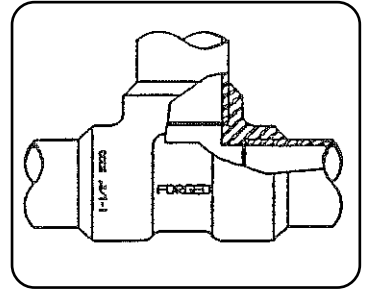

# FLANGES

The purpose of a flange is simply to join two pieces of pipe or connect valves or other similar items in a piping system. It may be cast or forged.

## FACINGS

One of the most important parts of the flange is the facing. Here are the most commonly used facings:

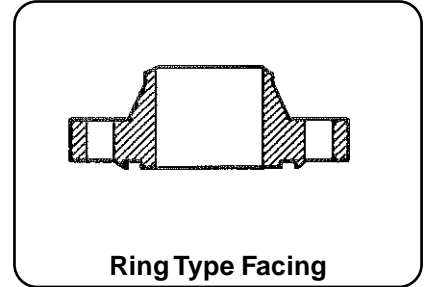
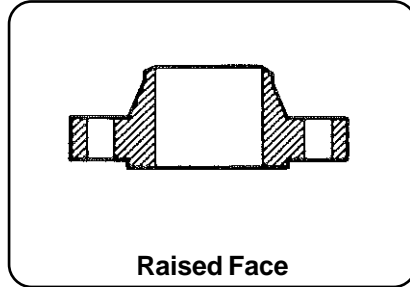
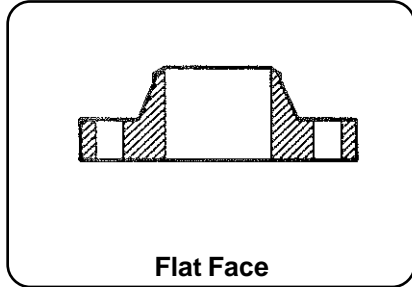

## STANDARD FLANGE DESIGNS

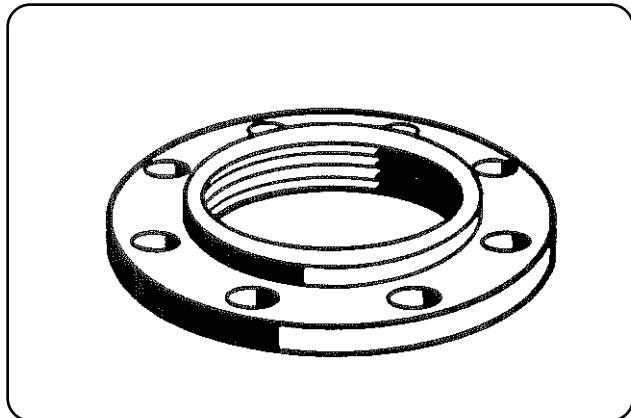

### THREADED

The bore of this flange is threaded to match the pipe size.

*Usage: Low pressure systems and where welding could be hazardous.*

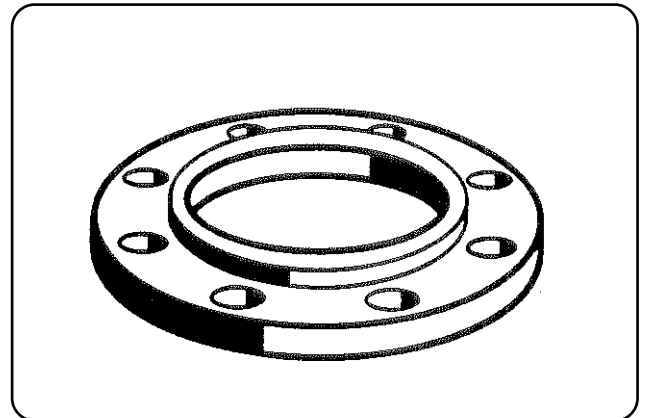

### LAP JOINT

Bored slightly larger than the OD of the pipe, the radius on the bottom matches the radius on the stub end. It is slipped over the pipe and a stub end is welded onto the pipe. The flange is then slipped over the stub end and bolted up.

*Usage: For systems that need frequent cleaning and/or inspection.*

# FLANGES

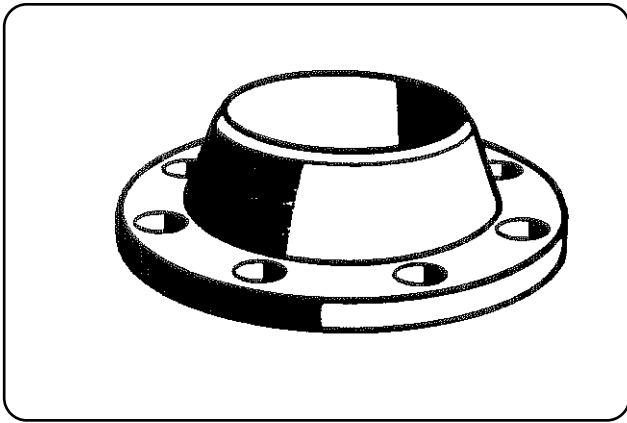

## WELDING NECK

Bored to the ID of the pipe and has a high neck to which pipe is welded. Probably the best welding flange available because of its high, heavy neck.

*Usage: Wherever a sound welded joint connection is needed.*

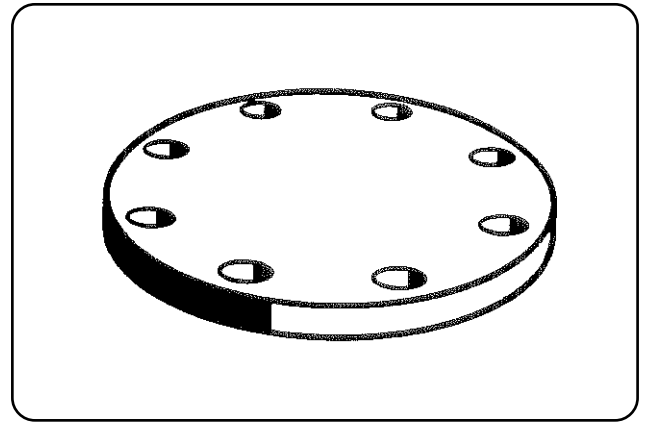

## BLIND FLANGE

As the name indicates this flange is a solid circle drilled to match a companion flange.

*Usage: To shut off or blank off piping.*

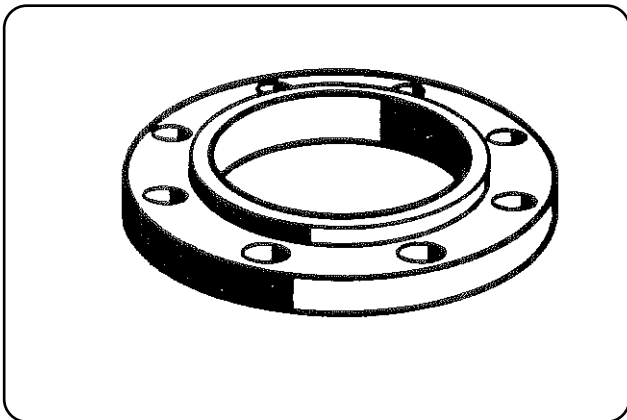

## SLIP-ON

Has a low hub and is bored slightly larger than the OD of the pipe. This flange is welded on both inside and outside of the flange face to prevent leakage.

*Usage: Used in lieu of welding necks when cost or space is a major consideration.*

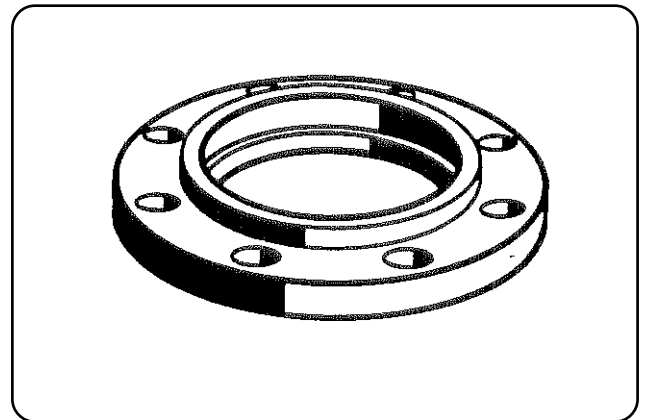

## SOCKET WELD

The socket weld flange is bored to the ID of the pipe and counter bored slightly larger than the OD of the pipe to allow the pipe to be inserted and welded in place.

*Usage: Usually NPS 4 - 300# & 600 + 150' up to NPS 24.*

## PRESSURE CLASSES

Generally flanges are manufactured in pressure classes of 150, 300, 400, 600, 900, 1500 and 2500 lbs.